

Pro-terrorist comix for today's kids

July 2026

Issue 2

\$1.00

FRIDAY NIGHT

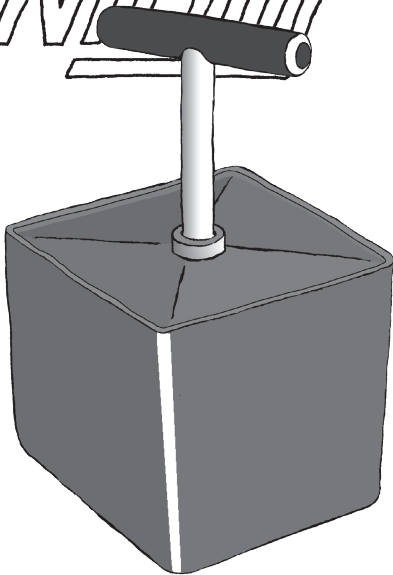

The author would like to thank
the Canada Council for the Arts,
without whose help and assistance
this comic was produced.

Victoria, BC.

Central Command,
Thursday, June 29,
5:47 p.m.

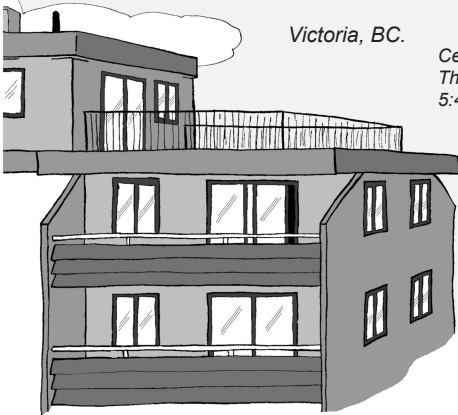

Let's smoke
a joint!

You always
say that.

And has it
ever been a
bad idea?

Canada Day is
this weekend.
Have you
come up with
a plan
of action?

Well, I have
an idea, but
it requires
knowledge
I do not yet
possess ...

*Pfp-
pffp-
fffp --!*

I sense a
research
expedition to
the university
library in our
future.

And guess
who I was
thinking
would
drive us
there?

Hey,
I'm
up
for
it!

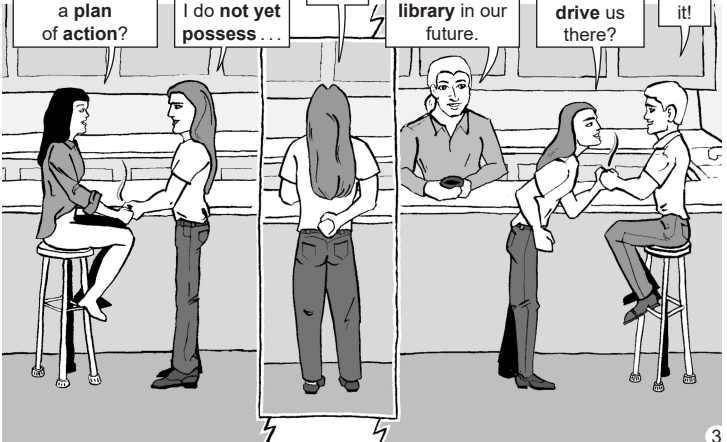

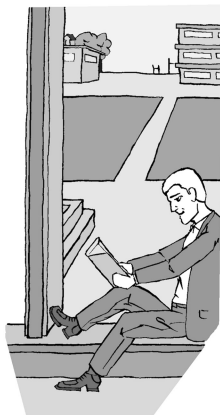
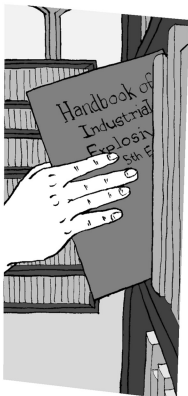
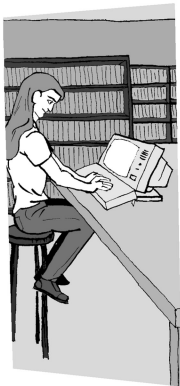

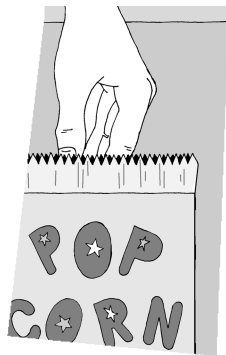
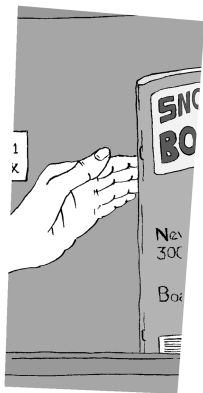

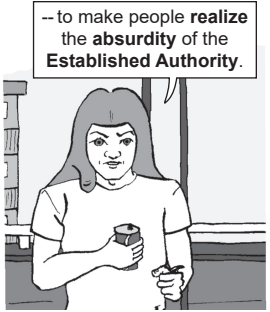
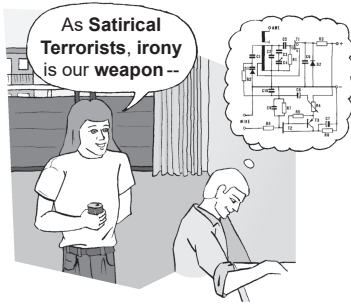

Parliament Buildings,
Saturday, July 1,
3:42 a.m.:

Just be
glad I
wore my
flats.



First, we tape
the receiver to
the pole ...



Then we wrap
the pole in
Primacord® ...



And we're
ready!



Isn't the driver
supposed to
wait in the
getaway car?

I know,
but I look
much cooler
like this.

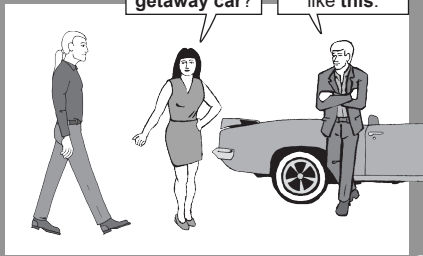

*Downtown alley,
Saturday, July 1,
8:58 p.m.*

*Our heroes make
necessary final
preparations...*

Pfp-
pffp-
fffp--!

Is it **time** yet?
Huh? **Now**? Huh?
How about **now**?
Yeah? **Now**?

It's
time.

Yes!



Thus resolved, the self-proclaimed Friday Knights issue their chilling war-cry:

Doing stupid things in public for no reason at all!



Parliament Buildings,

9:14 p.m.

Patriotic citizens enjoy the Canada Day fireworks . . .



Central Command,
9:50 p.m.:

Home again, home
again, jiggedy-jig!

Nothing to do now
but wait for the
media reaction.

If
any.



We took action.
We can't let
ourselves despair.

Yeah! If at first
you don't secede --



-- try, try again!

The Second Annual Canada Day Caper

By The Lone Banana

FRIDAY NIGHT COMICS is published by Eclectic Comics. This is Volume I, Number 2, July 2026 issue.

“The Second Annual Canada Day Caper” was first published in *Eclectic Comics* volume VIII, number 19, June / July 1995. That material is copyright © 1995 by The Lone Banana. This revised mini-comic is copyright © 2026 by The Lone Banana. All legal and moral rights are reserved.

Any inquiries should be emailed to MinorMogul@GMail.com or mailed to P.O. Box 692, Salt Spring Island, BC, V8K 2W3. Send \$5.00 for a copy of both Issue 1 and Issue 2 of FRIDAY NIGHT COMICS; please pay by cash, cheque, or Interac e-Transfer to the above addresses.

Subscribe to the newsletter! Email “Subscribe!” to the above address.

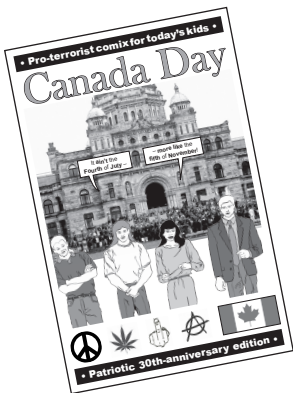

CANADA DAY features the first two “Canada Day Caper” stories of the Friday Knights, with a suggested gear list for the Satirical Terrorist. Feel like a revolutionary without ever leaving your couch!

32 satire-soaked pages in glorious black, white, and grey with a spot-colour cover!

Send \$5.00 postpaid by cash or cheque to P.O. Box 692, Salt Spring Island, BC, V8K 2W3; or by Interac e-Transfer to MinorMogul@GMail.com.

**It's spring in Vancouver ... Weed is legal ...
Love is in the air ... And everything is played for ...**

High Stakes

Help make an independent movie!

HIGH STAKES is an upcoming feature-length dramedy set in the cannabis-storefront world of Vancouver, BC.

The movie combines stoner comedy, romantic comedy, and screwball

comedy with heartfelt emotion to address themes of grief, loyalty, and doing the right thing. Plus laughs!

Visit the website to learn about the project, and how you can help!

HighStakesMovie.ca